

Diagrammed ASI Field Course Sequences

(Unfold for view of complete sequences.)

Technical Rescue for Volunteer and Professional Rescuers (Proposed)

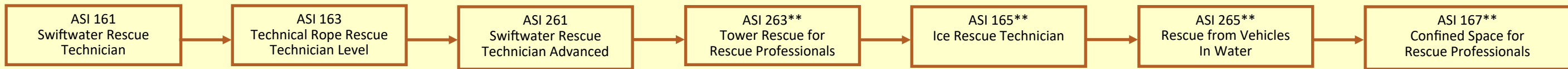

Back Country Living

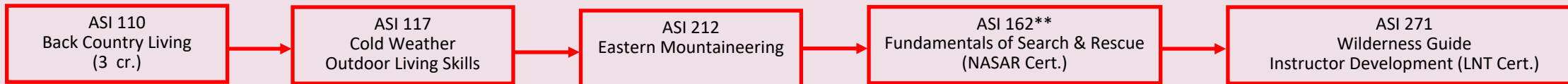

Challenge Course

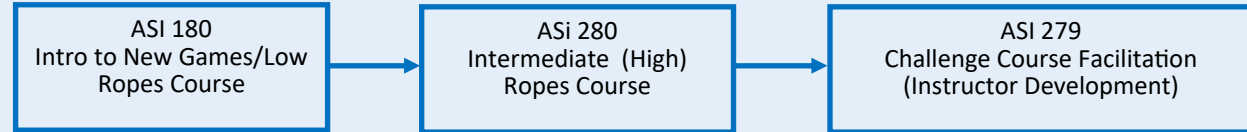

Mountain Biking

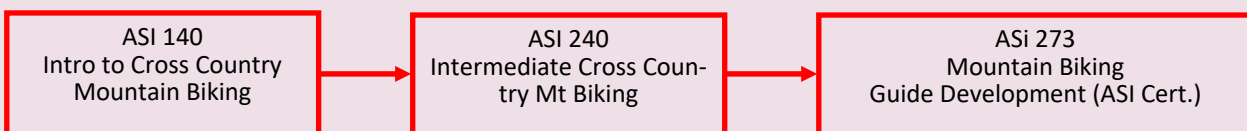

Nordic Skiing

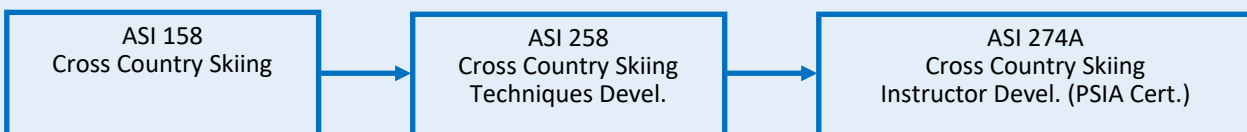

Telemark Skiing

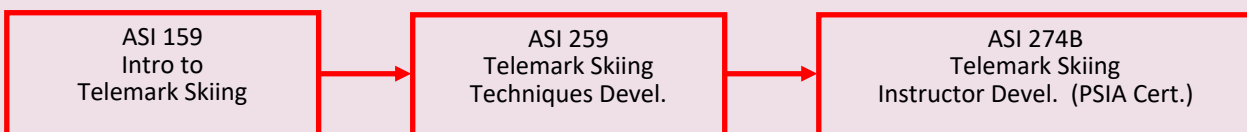

Alpine Skiing

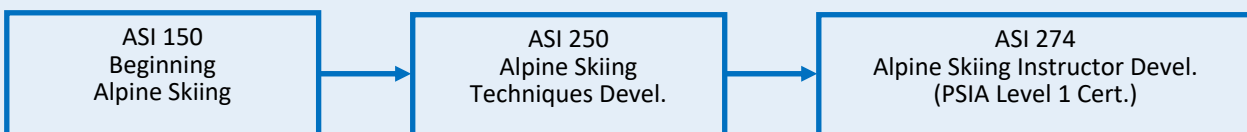

Stand Alone Courses

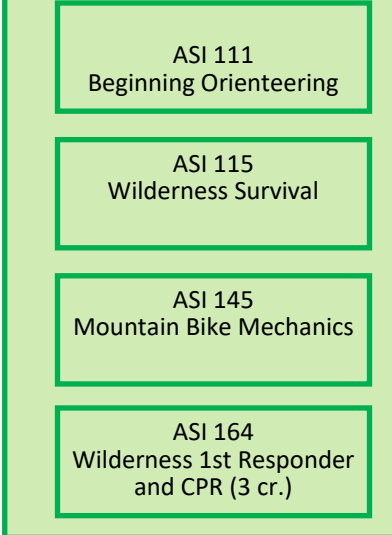

Sea Kayaking

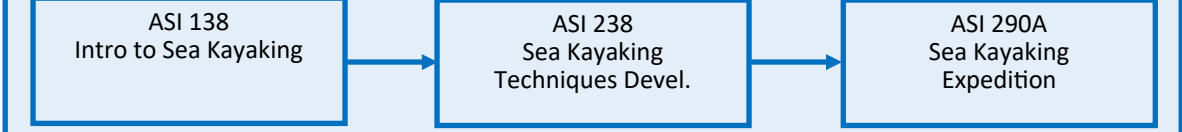

Snowboarding

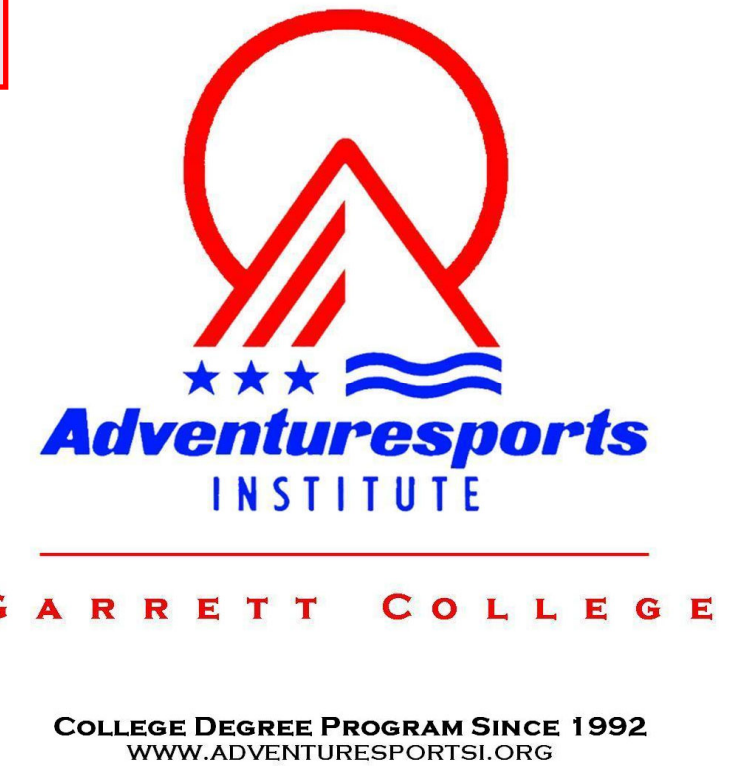
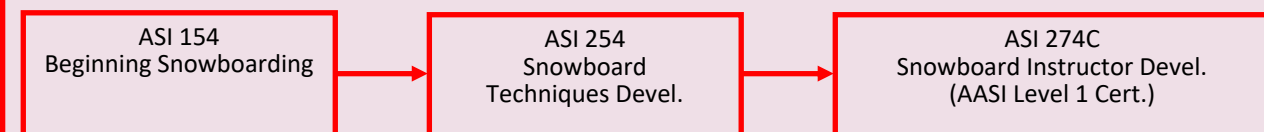

Diagrammed ASI Field Course Sequences

(Unfold for view of complete sequences.)

All courses are 1-credit, unless otherwise noted.

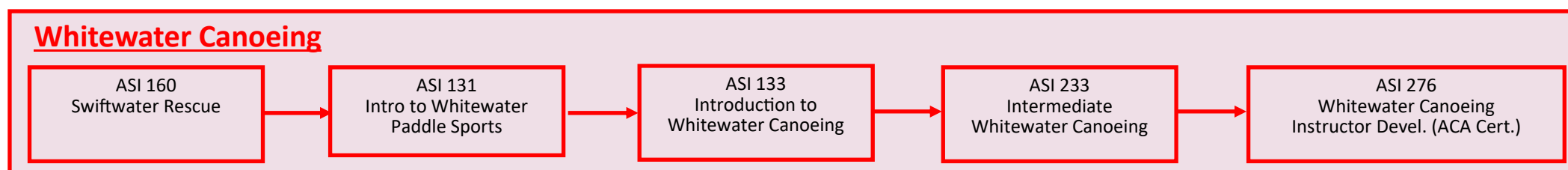
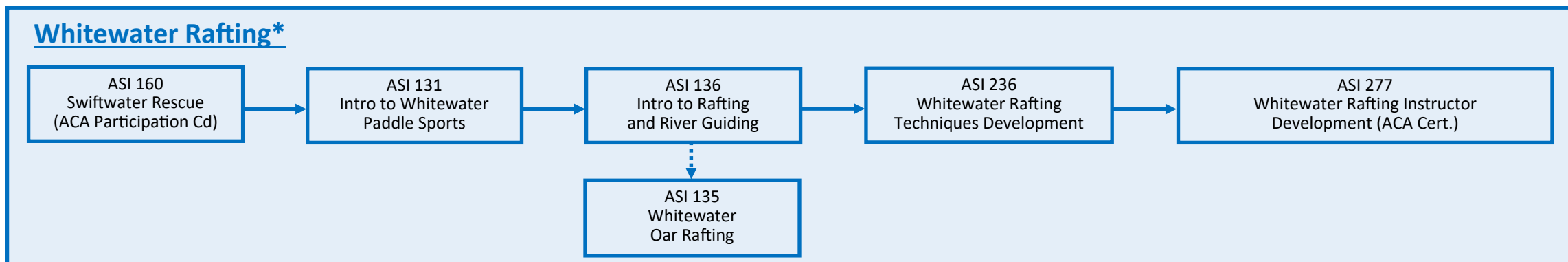
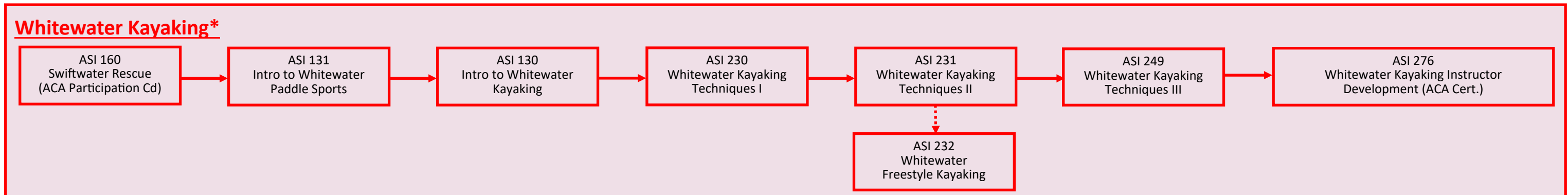
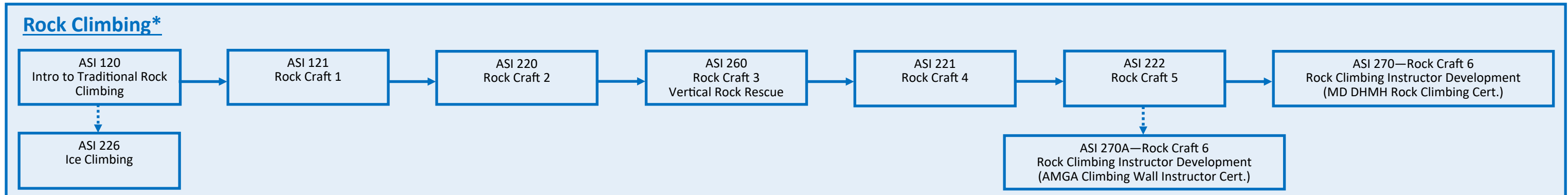

G A R R E T T C O L L E G E

NOTES:

1. *Completion of entire sequence yields a Garrett College *Letter of Recognition* (courses connected by ----▶ are not required).
2. **Denotes a course that can be taken out of sequence, except for any prerequisite requirements.
3. All ASI majors are required to successfully complete ASI 110 Back Country Living as a pre-requisite for ASI 120, ASI 162, and ASI 271.
4. All ASI majors are required to successfully complete ASI 164 Advanced First Aid & CPR, or an equivalent advanced first aid course, before graduation.
5. All ASI majors are required to successfully complete ASI 271 or ASI 271A Wilderness Guide Instructor Development (Leave-No-Trace Master Educator or Trainer respectively) before graduation.

COLLEGE DEGREE PROGRAM SINCE 1992
WWW.ADVENTURESPORTSI.ORG